

RL

RL

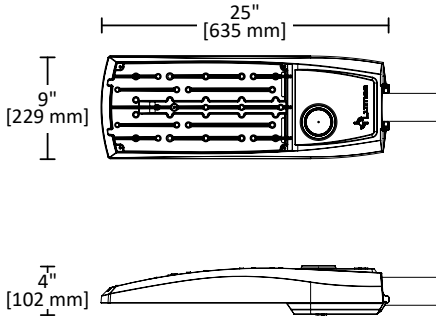

RL

RLG

Distributions

Type I L1 Type II L2B Type III L3



Type III L3FL Type IV L4 Type V L5



CCT CRI
3000K 4000K C70

Characteristics



Sources

Type I-II-III-V

530mA	700mA
18LED05 30W	18LED07 40W
36LED05 60W	36LED07 80W
54LED05 90W	54LED07RMD 120W*
72LED05RMD 120W*	72LED07RMD 160W*

Type IV

530mA	700mA
12LED05 20W	12LED07 27W
24LED05 40W	24LED07 54W
36LED05 60W	36LED07 80W
48LED05 80W	48LED07RMD 107W*

* Remote driver installed in the pole

RL

- Up to 160W
- Up to 21 000 lumens
- Weight: 13lb - 5.9kg
- EPA: 0.54 ft²

Description

Lumca's latest RL series is synonymous with ultramodern lighting. Blending clean lines with an elegance that stands the test of time, the RL series is the perfect solution for a truly distinctive look.

Construction

- Aluminum A380
- Minimum wall thickness of 0.125" [3mm]
- Stainless steel hardware
- Two mounting clamps c/w (4) hexagonal head stainless steel bolts 1/2-13 UNC - 25 lb/ft torque,
- Arm adaptor for 1.66" to 2.375" O.D. [42 mm to 60mm] arms, minimum arm length of 7" [178mm].
- Tilt : -2°, 0°, 3°, or 6°

Optical system

- Glare control lens (RLG only)
- Aluminum heat sink dissipator
- High intensity white light emitting diodes (LED)
- IP66

Driver

- Constant current, -40°C [-40°F] to 80°C [176°F], PF 0,99, 0-10V, 120 to 277V / 347 - 480V.
- Option PRG: Programmable Driver (Consult factory for scenario options)

Voltage

120 - 208 - 240 - 277 - 347 - 480

Finish

- **PlafORIZATION** (All metallic parts are pretreated using an environmentally friendly organic phosphating technology)
- Polyester powder coating
- Minimum thickness of 100 microns
- Meet ASTM B117 standards
- Meet ASTM D2247 standards

Available options

- HSS House side shield (internal)
- SGP Surge protector 10kV or 20kV
- PRG Programmable driver
- MS-24X Motion sensor (max. 80W (36LED))
- TRP7 7 pins twist lock photocell receptacle (ANSI C136.41) C/W shorting cap
- TRP 7 pins twist lock photocell receptacle (ANSI C136.41) C/W photocell
- PER Twist lock photocell receptacle (ANSI C136.41)

Date _____

City _____

Project name _____

Type _____

Qty. _____



Color charts



IES files



Photometrics chart



Options datasheet

Product code	Source	Voltage	Distribution	CCT	Options	Color
RL	Type I-II-III-V	120	L1	30K	*See options below*	*see color chart*
RLG	18LED05 30W	208	L2B	40K		
	36LED05 60W	240	L3			
	54LED05 90W	277	L3FL			
	72LED05RMD 120W	347	L4			
		480	L5			
	18LED07 40W					
	36LED07 80W					
	54LED07RMD 120W					
	72LED07RMD 160W					
	Type IV					
	12LED05 20W					
	24LED05 40W					
	36LED05 60W					
	48LED05 80W					
	12LED07 27W					
	24LED07 54W					
	36LED07 80W					
	48LED07RMD 107W					

Code example: RL 36LED07 80W 120V L3FL 40K SG

House side shield	Surge protector	Motion sensor	Programmable driver	Photocell
HSS	SGP-10 (120-277V) SGP-20 (120-277V) SGP-10HV (347-480V) SGP-20HV (347-480V)	MS-24L MS-24M MS-24H	PRG	TRP7 TRP PER

- HSS House side shield (internal, field installable)
- SGP Surge protector 10kV or 20kV
- PRG Programmable driver (consult factory for scenario options)
- MS-24X Motion sensor with Low, Medium and High range lens (Max. 80W (36LED))

- TRP7 7 pins twist lock photocell receptacle (ANSI C136.41) C/W shorting cap
- TRP 7 pins twist lock photocell receptacle (ANSI C136.41) C/W photocell
- PER Twist lock photocell receptacle (ANSI C136.41)

RL

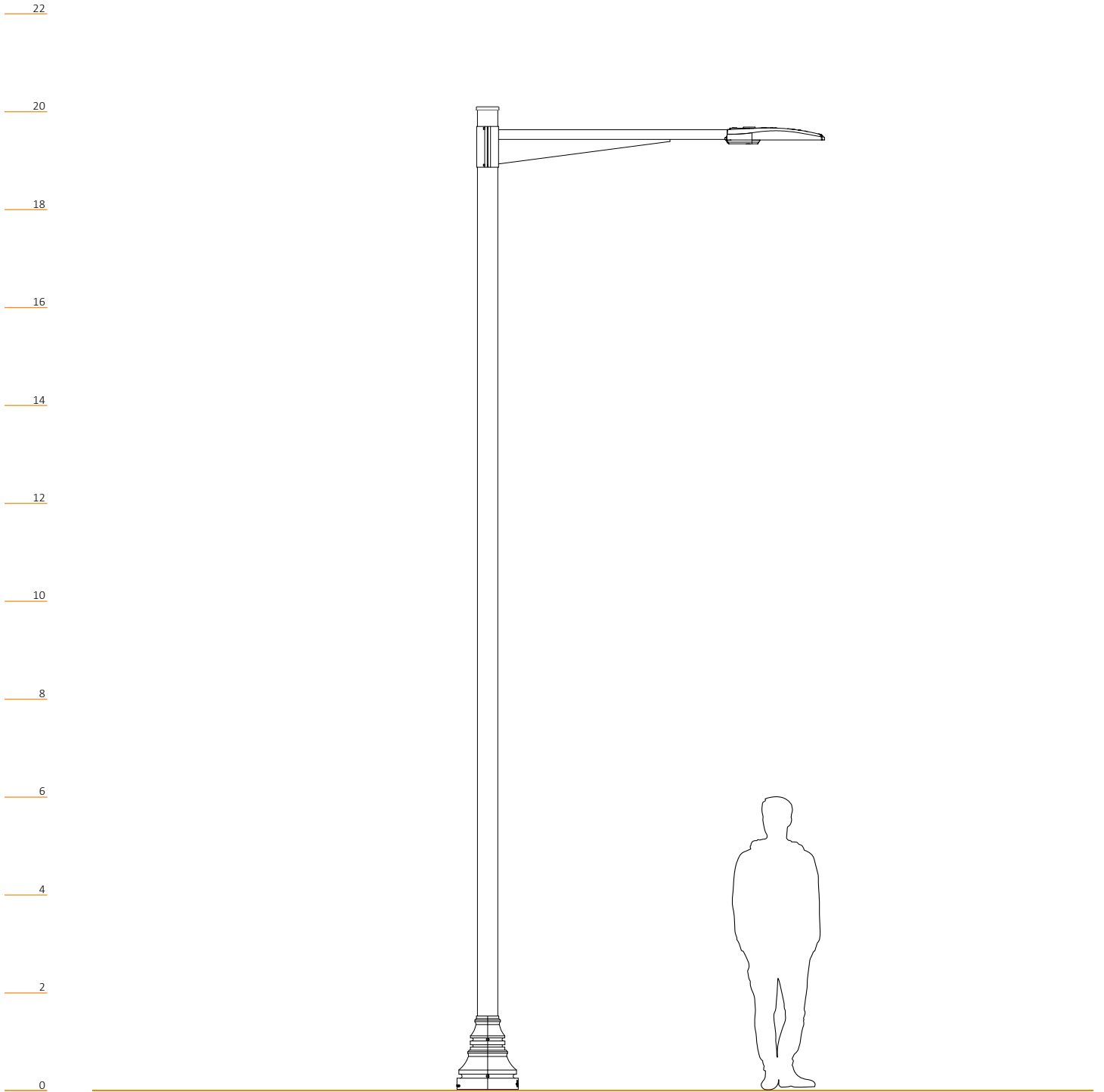

Luminaire: RL
Mounting arms: M1A-CF71
Pole: AP05-20
Base cover: WB9-5

LUMINAIRE OPTIONS

TRP

7 pins twist lock photocell receptacle C/W photocell.

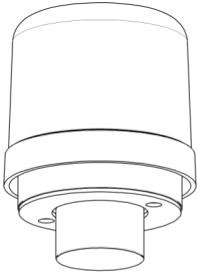

TRP7

7 pins twist lock photocell receptacle C/W shorting cap.

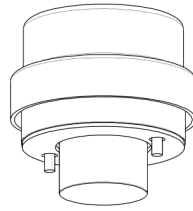

PER

Twist lock photocell receptacle only.

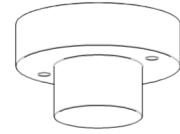

RCD-DOF

Remote controlled dimmer (Software not included).

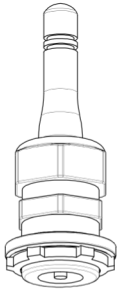

BTP

Button type photocell

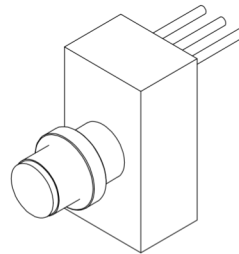

HSS

House side shield. (Directly mounted on optical lens)

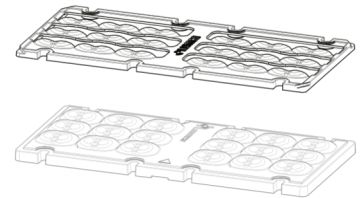

SGP-10

10 KV Surge protection
Also available SGP-10HV (for Hight voltage, 347-480V)

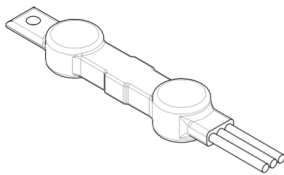

SGP-20

20 KV Surge protection
Also available SGP-20HV (for Hight voltage, 347-480V)

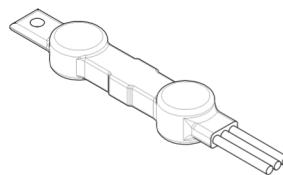

MS-24L

Title 24 Motion sensor C/W Low range lens.

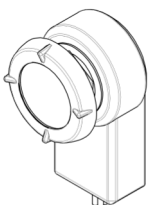

MS-24M

Title 24 Motion sensor C/W Medium range lens



MS-24H

Title 24 Motion sensor C/W High rang lens

